

MECHANICAL DATA

**GOLD METALLISED
MULTI-PURPOSE SILICON
DMOS RF FET
125W – 28V – 500MHz
PUSH-PULL**

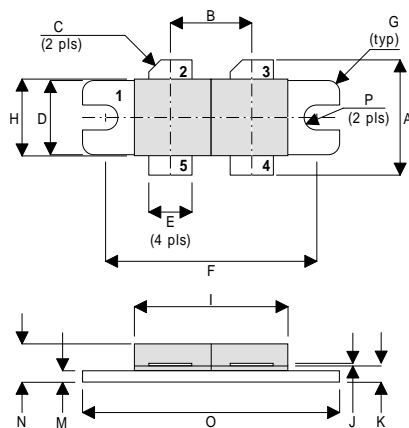

DR

PIN 1 SOURCE (COMMON) PIN 2 DRAIN 1
 PIN 3 DRAIN 2 PIN 4 GATE 2
 PIN 5 GATE 1

DIM	Millimetres	Tol.	Inches	Tol.
A	19.05	0.50	0.75	0.020
B	10.77	0.13	0.424	0.005
C	45°	5°	45°	5°
D	9.78	0.13	0.385	0.005
E	5.71	0.13	0.225	0.005
F	27.94	0.13	1.100	0.005
G	1.52R	0.13	0.060R	0.005
H	10.16	0.13	0.400	0.005
I	22.22	MAX	0.875	MAX
J	0.13	0.02	0.005	0.001
K	2.72	0.13	0.107	0.005
M	1.70	0.13	0.067	0.005
N	5.08	0.50	0.200	0.020
O	34.03	0.13	1.340	0.005
P	1.61R	0.08	0.064R	0.003

FEATURES

- SIMPLIFIED AMPLIFIER DESIGN
- SUITABLE FOR BROAD BAND APPLICATIONS
- LOW C_{rss}
- SIMPLE BIAS CIRCUITS
- LOW NOISE
- HIGH GAIN – 10 dB MINIMUM

APPLICATIONS

- HF/VHF/UHF COMMUNICATIONS
from 1 MHz to 500 MHz

ABSOLUTE MAXIMUM RATINGS ($T_{case} = 25^{\circ}C$ unless otherwise stated)

P_D	Power Dissipation	389W
BV_{DSS}	Drain – Source Breakdown Voltage *	70V
BV_{GSS}	Gate – Source Breakdown Voltage *	±20V
$I_{D(sat)}$	Drain Current *	20A
T_{stg}	Storage Temperature	-65 to 150°C
T_j	Maximum Operating Junction Temperature	200°C

* Per Side

Semelab Plc reserves the right to change test conditions, parameter limits and package dimensions without notice. Information furnished by Semelab is believed to be both accurate and reliable at the time of going to press. However Semelab assumes no responsibility for any errors or omissions discovered in its use. Semelab encourages customers to verify that datasheets are current before placing orders.

ELECTRICAL CHARACTERISTICS (T_{case} = 25°C unless otherwise stated)

Parameter	Test Conditions	Min.	Typ.	Max.	Unit
PER SIDE					
B _V DSS	Drain–Source Breakdown Voltage	V _{GS} = 0	I _D = 100mA	70	V
I _D DSS	Zero Gate Voltage Drain Current	V _{DS} = 28V	V _{GS} = 0		4 mA
I _G DSS	Gate Leakage Current	V _{GS} = 20V	V _{DS} = 0		1 μA
V _{GS(th)}	Gate Threshold Voltage*	I _D = 10mA	V _{DS} = V _{GS}	1	7 V
g _{fs}	Forward Transconductance*	V _{DS} = 10V	I _D = 4A	3.2	S
TOTAL DEVICE					
G _{PS}	Common Source Power Gain	P _O = 125W		10	dB
η	Drain Efficiency	V _{DS} = 28V	I _{DQ} = 2A	50	%
VSWR	Load Mismatch Tolerance	f = 400MHz		20:1	—
PER SIDE					
C _{iss}	Input Capacitance	V _{DS} = 0	V _{GS} = -5V f = 1MHz		240 pF
C _{oss}	Output Capacitance	V _{DS} = 28V	V _{GS} = 0 f = 1MHz		100 pF
C _{rss}	Reverse Transfer Capacitance	V _{DS} = 28V	V _{GS} = 0 f = 1MHz		10 pF

* Pulse Test: Pulse Duration = 300 μs , Duty Cycle ≤ 2%

HAZARDOUS MATERIAL WARNING

The ceramic portion of the device between leads and metal flange is beryllium oxide. Beryllium oxide dust is highly toxic and care must be taken during handling and mounting to avoid damage to this area.

THESE DEVICES MUST NEVER BE THROWN AWAY WITH GENERAL INDUSTRIAL OR DOMESTIC WASTE.

THERMAL DATA

R _{THj-case}	Thermal Resistance Junction – Case	Max. 0.45°C / W
-----------------------	------------------------------------	-----------------

Semelab Plc reserves the right to change test conditions, parameter limits and package dimensions without notice. Information furnished by Semelab is believed to be both accurate and reliable at the time of going to press. However Semelab assumes no responsibility for any errors or omissions discovered in its use. Semelab encourages customers to verify that datasheets are current before placing orders.

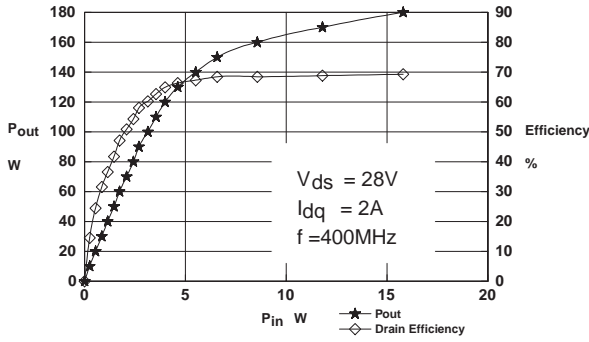

Figure 1 – Power Output and Efficiency vs. Power Input.

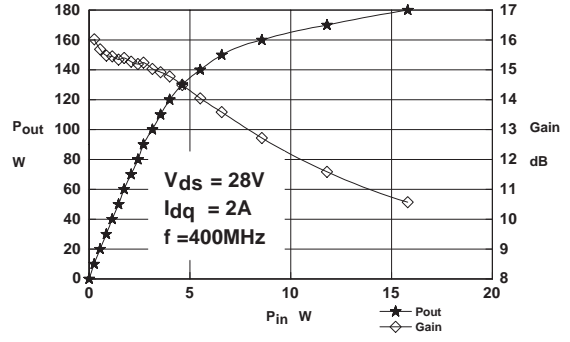

Figure 2 – Power Output & Gain vs. Power Input.

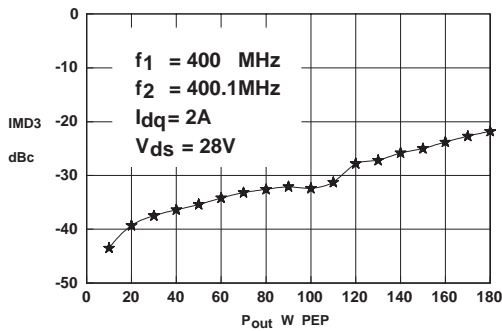

Figure 3 – IMD vs. Output Power.

D1010UK OPTIMUM SOURCE AND LOAD IMPEDANCE

Frequency MHz	Z_S Ω	Z_L Ω
400	$1.7 + j0.1$	$2.7 + j1$

Typical S Parameters

! Vds=28V Idq=1A per side
MHZ S MA R 50

!Freq !MHz	S11		S21		S12		S22	
	mag	ang	mag	ang	mag	ang	mag	ang
20	0.729	-173.6	20.47	103.6	0.011	25	0.557	-172.3
30	0.72	-172.9	20.57	97.4	0.012	13.7	0.5664	-169.2
40	0.725	-171.7	18.45	91.1	0.012	7.4	0.5848	-167.8
50	0.745	-171.5	14.74	85.1	0.011	3.1	0.6097	-165.5
60	0.758	-170.7	12.21	79.6	0.011	0.7	0.6365	-164.4
70	0.773	-171	10.35	75.6	0.01	-1.1	0.6634	-163.7
80	0.794	-170.6	8.943	70.5	0.01	-2.4	0.6935	-163.8
90	0.81	-170.6	7.829	65.7	0.009	-3.2	0.712	-164
100	0.831	-170.9	6.878	61.9	0.009	-2.6	0.734	-163.6
110	0.841	-171.4	6.107	58.6	0.008	-2.4	0.7559	-164
120	0.852	-171.8	5.449	54.9	0.007	-1	0.7685	-164.8
130	0.862	-172.1	4.877	52.4	0.007	1.9	0.7902	-165.2
140	0.871	-172.6	4.373	48.8	0.006	4.8	0.8089	-166
150	0.885	-173.1	3.949	46.1	0.006	8.8	0.8248	-165.9
160	0.895	-173.5	3.574	42.4	0.006	13.8	0.8333	-166.9
170	0.901	-174.1	3.246	40.4	0.005	19.7	0.8413	-167.7
180	0.905	-175.2	2.948	38.5	0.005	26.8	0.8512	-168.5
190	0.911	-175	2.688	36.6	0.005	35.5	0.8696	-168.5
200	0.915	-175.8	2.486	36	0.005	42.5	0.871	-169.4
210	0.922	-175.8	2.313	35	0.006	50.3	0.8817	-169.4
220	0.933	-176.4	2.16	33.7	0.006	56.4	0.8865	-170.3
230	0.927	-176.4	2.013	31.9	0.006	60.1	0.8966	-171
240	0.93	-177.3	1.866	29.5	0.007	62.9	0.8999	-171.5
250	0.938	-177.2	1.729	27.4	0.007	66.7	0.9096	-171.4
260	0.939	-178.4	1.617	26.1	0.008	70.8	0.9101	-172.3
270	0.94	-178.6	1.502	24.8	0.008	73.5	0.9152	-172.5
280	0.942	-179	1.433	24.5	0.009	76.7	0.9159	-173
290	0.95	-179.9	1.359	25.1	0.01	80.4	0.923	-173.6
300	0.944	-179.3	1.3	24.1	0.011	81.3	0.9216	-173.9
310	0.951	-179.5	1.238	22.3	0.012	81.5	0.9297	-174.8
320	0.952	179.6	1.184	20.4	0.012	80.4	0.9345	-174.8
330	0.954	-179.9	1.115	18.3	0.013	79	0.9344	-175.4
340	0.963	179.2	1.04	15.7	0.013	77.5	0.9394	-175.6
350	0.953	178.9	0.964	13.8	0.014	77.5	0.9382	-176.2
360	0.96	178.3	0.9	13	0.014	78.1	0.943	-176.2
370	0.96	178.4	0.847	13.1	0.015	78.6	0.9437	-176.8
380	0.96	177.7	0.802	13.1	0.015	79.6	0.9458	-176.9
390	0.963	177.5	0.744	12.6	0.015	78.6	0.9475	-177.2
400	0.964	177	0.704	16.9	0.015	82.9	0.9492	-177.5
410	0.966	176.5	0.721	16.3	0.017	84	0.9527	-177.3
420	0.964	176.8	0.704	14.6	0.018	83.1	0.9499	-178.2
430	0.965	176.5	0.677	12.1	0.018	81.8	0.9556	-178.2
440	0.965	175.6	0.64	10.3	0.019	80.5	0.9593	-178.8
450	0.967	175.3	0.605	9.7	0.019	81	0.9546	-179
460	0.968	175.1	0.576	8.8	0.019	81.2	0.9598	-179.7
470	0.967	175.2	0.552	9.4	0.02	82.4	0.9599	-179.4
480	0.966	174.8	0.53	9.7	0.02	83.6	0.9608	-179.9
490	0.967	174.3	0.512	9.4	0.021	83.2	0.9604	179.8
500	0.967	173.9	0.503	9.5	0.022	83.8	0.9596	179.5

Semelab Plc reserves the right to change test conditions, parameter limits and package dimensions without notice. Information furnished by Semelab is believed to be both accurate and reliable at the time of going to press. However Semelab assumes no responsibility for any errors or omissions discovered in its use. Semelab encourages customers to verify that datasheets are current before placing orders.

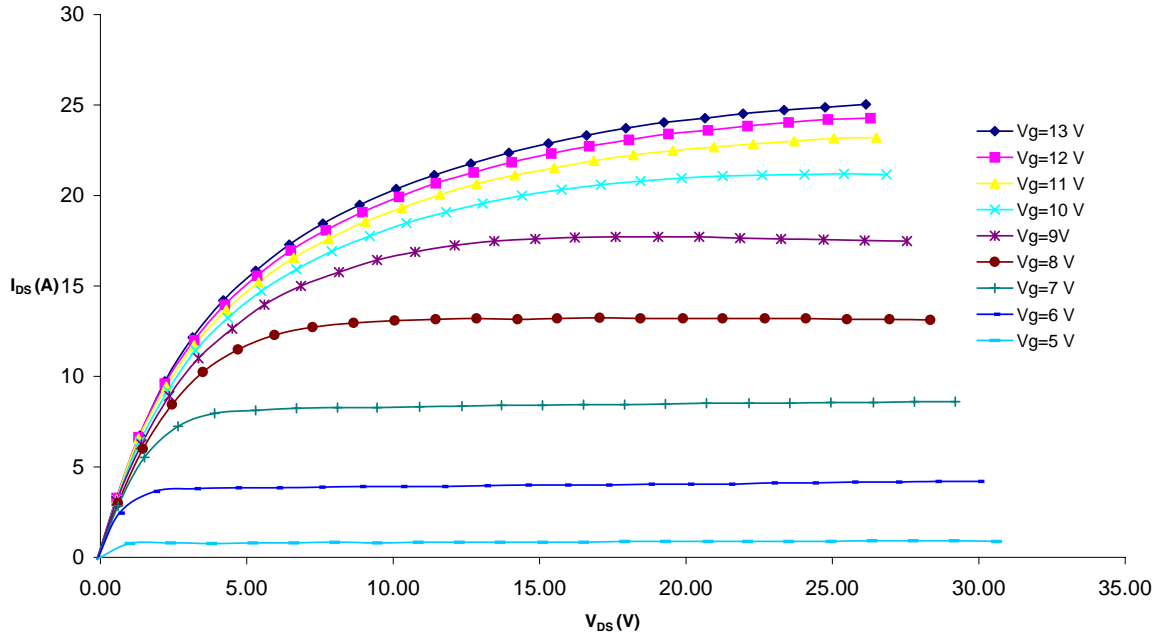

Figure 4 – Typical IV Characteristics.

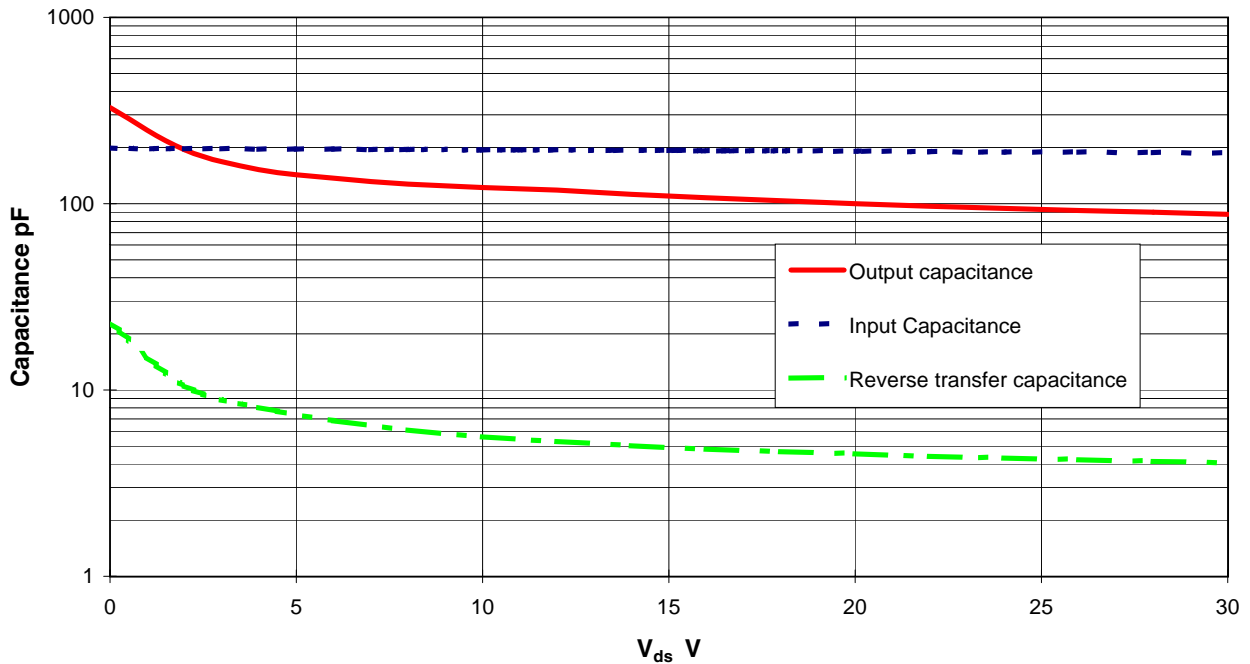
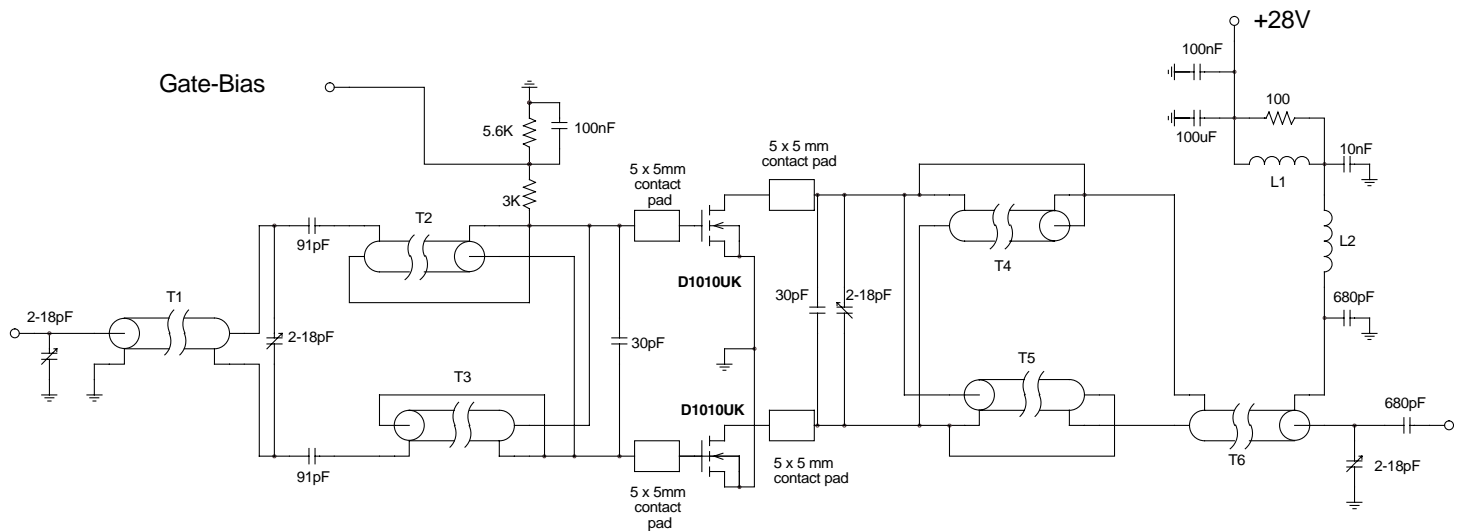

Figure 5 – Typical CV Characteristics.

Semelab Plc reserves the right to change test conditions, parameter limits and package dimensions without notice. Information furnished by Semelab is believed to be both accurate and reliable at the time of going to press. However Semelab assumes no responsibility for any errors or omissions discovered in its use. Semelab encourages customers to verify that datasheets are current before placing orders.



D1010UK TEST FIXTURE

Substrate 1.6mm PTFE/ glass, Er= 2.5
All microstrip lines W= 4.4mm

T1	12cm	50Ω UT85 semi-rigid coax on ferrite core
T2,3	7.5cm	15Ω UT85-15 semi-rigid coax
T4,5	7cm	15Ω UT85-15 semi-rigid coax
T6	11cm	50Ω UT85 semi-rigid coax on ferrite core
L1	6.5 turns	25swg enamelled copper wire on Fair-Rite FT50B-43 core
L2	6.5 turns	25swg enamelled copper wire, 4mm internal diameter